

**ALBERTA GOVERNMENT SERVICES
LAND TITLES OFFICE**

IMAGE OF DOCUMENT REGISTERED AS:

152134165

ORDER NUMBER: 28427593

ADVISORY

This electronic image is a reproduction of the original document registered at the Land Titles Office. Please compare the registration number on this coversheet with that on the attached document to ensure that you have received the correct document. Note that Land Titles Staff are not permitted to interpret the contents of this document.

Please contact the Land Titles Office at (780) 422-7874 if the image of the document is not legible.

CAVEAT

TO THE REGISTRAR OF THE ALBERTA LAND TITLES OFFICE

TAKE NOTICE that **JAGARE RIDGE HOMEOWNERS ASSOCIATION** of Edmonton, in the Province of Alberta, and **JAGARE RIDGE COMMUNITIES INC.**, of Edmonton, in the Province of Alberta (together the "Caveator"), each claim an interest under and by virtue of a Restrictive Covenant in writing, dated May 1, 2015, and made between **JAGARE RIDGE COMMUNITIES INC.**, as registered owner, and the Caveator whereby the said registered owner and the Caveator agreed, all in accordance with the terms of the said Restrictive Covenant, a true copy of which is attached to and forms part of this Caveat, in the lands described as follows:

See Schedule "A" attached hereto.

standing in the register in the name of **JAGARE RIDGE COMMUNITIES INC.**, and the Caveator forbids the registration of any person as transferee or owner of, or of any instrument affecting the said estate or interest, unless the instrument or Certificate of Title, as the case may be, is expressed to be subject to the Caveator's claim.

THE CAVEATOR DESIGNATES 900, 10310 Jasper Avenue, Edmonton, AB, T5J 1Y8, as the place at which notices and proceedings relating hereto may be served.

Dated this 1st day of May, 2015.

JAGARE RIDGE HOMEOWNERS ASSOCIATION
 Corporate Seal
 PER: _____
 PER: _____

JAGARE RIDGE COMMUNITIES INC.
 Corporate Seal
 PER: _____
 PER: _____

AFFIDAVIT IN SUPPORT OF CAVEAT

I, KAREN ALBARDA, of the City of Edmonton, in the Province of Alberta, MAKE OATH AND SAY AS FOLLOWS:

1. That I am Agent for the Caveator.
2. I believe that the said Caveator has a good and valid claim upon the said land and I say that this Caveat is not being filed for the purpose of delaying or embarrassing any person interested in or proposing to deal therewith.

SWORN BEFORE ME Tanya Eklund
at the City of Edmonton, in the
Province of Alberta, this 1st
Day of May, A.D. 2015

Tanya Eklund

A COMMISSIONER FOR OATHS IN AND
FOR THE PROVINCE OF ALBERTA

)
)
) Karen Albar
) KAREN ALBARDA
)

TANYA L. EKLUND
COMMISSION EXPIRES
MAY 24th, 2016

RESE

SCHEDULE "A"

PLAN 142 5414
BLOCK 4
LOTS 22 - 48 INCLUSIVE
EXCEPTING THEREOUT ALL MINES AND MINERALS

PLAN 142 5414
BLOCK 5
LOTS 16 - 29 INCLUSIVE
EXCEPTING THEREOUT ALL MINES AND MINERALS

PLAN 142 5414
BLOCK 6
LOTS 1 - 18 INCLUSIVE
EXCEPTING THEREOUT ALL MINES AND MINERALS

RESTRICTIVE COVENANT

MADE AS OF THIS 1st day of May, 2015.

BETWEEN:

JAGARE RIDGE COMMUNITIES INC.

a body corporate incorporated under the laws of the Province of Alberta
(hereinafter called the "Grantor/Grantee")

OF THE FIRST PART

- and -

JAGARE RIDGE HOMEOWNERS ASSOCIATION,

a society incorporated under the Societies Act of Alberta, with
registered office at 900, 10310 Jasper Avenue, in the City of
Edmonton, in the Province of Alberta, T5J 1Y8
(hereinafter called the "Grantee")

OF THE SECOND PART

RESTRICTIVE COVENANT

WHEREAS:

- a. The Grantor/Grantee is the registered owner of the Dominant Lands and the Servient Lands described in Schedule "A" hereto situate in City of Edmonton, Alberta.
- b. The Grantor/Grantee intends to impose a scheme of mutually enforceable restrictions with respect to the use and improvements on the Lands in order to preserve the integrity of the Development.

NOW THEREFORE:

The Grantor/Grantee as registered owner of the Servient Lands described in Schedule "A" does grant and the Grantor does hereby declare, establish, impose and annex to the Servient Lands and each and every portion thereof for the benefit of the Dominant Lands, the following stipulations, restrictions, guidelines and provisions to run with the Lands and be binding upon the owners from time to time of the Lots:

1. In this Restrictive Covenant, including the preamble, the following words and expressions shall have the meaning herein set forth:
 - a. "**Architectural Committee**" means a committee established by the Grantor/Grantee for so long as the Grantor/Grantee remains an Owner, and thereafter established by the Homeowners Association;
 - b. "**Development**" means the residential subdivision plan within which the Lots are located;

- c. **“Dominant Lands”** means the leasehold and easement interests of the Homeowner’s Association, granted to the Homeowner’s Association in the lands described in Schedule “A” hereto;
 - d. **“Dwelling”** means any residential dwelling constructed on any of the Lots;
 - e. **“Guidelines”** means the Architectural and Construction Guidelines attached hereto as Schedule “B” and as may be amended from time to time by the Architectural Committee;
 - f. **“Homeowners Association”** means the Jagare Ridge Homeowners Association;
 - g. **“Lands”** means the lands described in Schedule ‘A’ hereto;
 - h. **“Lot”** means one of the lots described in Schedule ‘A’ hereto and any further subdivision of such lots;
 - i. **“Owner”** means a registered owner in fee simple of a Lot;
 - j. **“Restrictions”** means the provisions, restrictions and stipulations contained in Paragraph 2 of this Restrictive Covenant;
 - k. **“Restrictive Covenant”** means this agreement as the same may be amended from time to time and the expressions “herein”, “hereof”, “hereto”, “above”, “below”, and similar expressions if used in any article, section or paragraph of this agreement refer to this agreement including the schedules hereto and do not refer solely to a particular article, section or paragraph unless specifically stated herein;
 - l. **“Servient Lands”** means the lands described as such in Schedule ‘A’ hereto.
2. For each of the Lots comprising the Servient Lands, for the benefit of the Dominant Lands, the following restrictions, stipulations and provisions are to run with the Lands, namely:
- a. No motor homes, recreational vehicles, trailers, boats or similar vehicles shall be stored for any period exceeding seven (7) days or for any period aggregating fourteen (14) days in a twelve month period on the front driveway, nor on the side yard, nor on any driveway of any building on any of the Lots, unless within an enclosure approved by the Architectural Committee, or as required by Municipal Bylaw as amended from time to time.
 - b. No satellite dishes shall be constructed, installed, placed, kept or maintained on any roof, front or side yard of any Dwelling, unless first approved by the Architectural Committee;
 - c. No radio or television aerials or antenna of any kind shall be erected, constructed or placed on any Dwelling or on any of the Lots, unless first approved by the Architectural Committee and unless the said aerial or antenna is a single unit incorporated into the structure of the Dwelling;

- d. No construction of the Dwelling may commence unless the building plans have been approved by the Architectural Committee;
 - e. No dwelling may be constructed unless said Dwelling conforms with the Guidelines attached hereto as Schedule "B";
3. If any of the Restrictions herein or the application thereof to any part or any circumstances shall be held by any Court of competent jurisdiction to be invalid or unenforceable to any extent, then such Restriction shall be severed from the remainder of this Restrictive Covenant, and the remainder of this Restrictive Covenant or application of such Restriction to a party or circumstance other than those to which it is held invalid or unenforceable shall not be affected thereby and each of the remaining Restrictions of this Restrictive Covenant shall be valid and enforceable to the fullest extent permitted by the law.
4. This Restrictive Covenant is in addition to the requirements of the municipal or other government authorities having jurisdiction in respect of the use of the Lands, and nothing contained herein shall be construed as permitting or authorizing anything which is prohibited, controlled or regulated by any statute, bylaw, regulation or like enactment having the force of law and having application to the lands.
5. Nothing herein shall require or oblige the Grantee to enforce this Restrictive Covenant or render the Grantee liable for the failure of any of the Owners from time to time of the Lots to adhere to or conform with the Restrictions contained in this Restrictive Covenant, it being the intention to attach to each of the Lots and the Owners thereof the obligation for compliance with this Restrictive Covenant.
6. The Restrictions contained in this Restrictive Covenant shall be binding upon and enure to the benefit of the Owner from time to time of each of the Lots and the Grantee and the restrictions herein shall run with the Lands and each of the Lots.

IN WITNESS WHEREOF these presents have been executed by each of the parties hereto the day and year first above written under its corporate seal and by the hands of its officers duly authorized in that behalf.

JAGARE RIDGE COMMUNITIES INC.

Per: _____

Per: _____



JAGARE RIDGE HOMEOWNERS ASSOCIATION

Per: _____

Per: _____



SCHEDULE "A"

TO RESTRICTIVE COVENANT AGREEMENT

The Current Lots are legally described as follows, all being lots shown on the subdivision plan registered as Plan No. 142 5414, namely:

Block 4, Lots 22 - 48 inclusive

Block 5, Lots 16 - 29 inclusive

Block 6, Lots 1 - 18 inclusive

SCHEDULE "B"

ARCHITECTURAL AND CONSTRUCTION GUIDELINES

THE HOMES OF JAGARE RIDGE

Objective

The general objective of these guidelines is to express lifestyle through design, creating harmonious streetscapes comprised of varied architectural styles that are distinctive and uniquely unified.

Architectural Theme

The architecture of Jagare Ridge will embody a diverse range of styles. An eclectic blend of classic and sophisticated homes will have stylistic definition identifiable to a period original. Diverse in styling and compelling in their range and declaration, homes will exemplify style. These guidelines include style profiles for the following vernaculars (See Pages 2 - 8):

Prairie	Craftsman
Tudor	Contemporary International
Modern Contemporary	French Country
Georgian	

Each home will draw details and characteristics from only one architectural style. It shall be the responsibility of the applicant to demonstrate the merits and characteristics of an architectural period style. Acceptability of such designs will rest solely with the Developer.

All architectural styles will be considered on the basis of the following criteria:

- Scale and proportion
- Appropriate image and style (all architectural elements and features are consistent with the vernacular)
- Relationship with neighboring homes
- Appropriate finishes and colors

Streetscape

The scale massing of each home will reflect architectural intent and style with careful consideration of relationship and orientation. A variety of designs will ensure diversity with no predominance of style.

Second floor decks and balconies at street elevations and in high visibility settings, will be understated and integrated into the building mass and/or roof line.

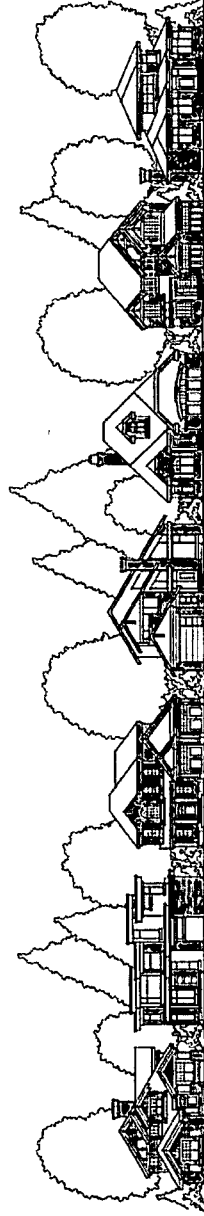

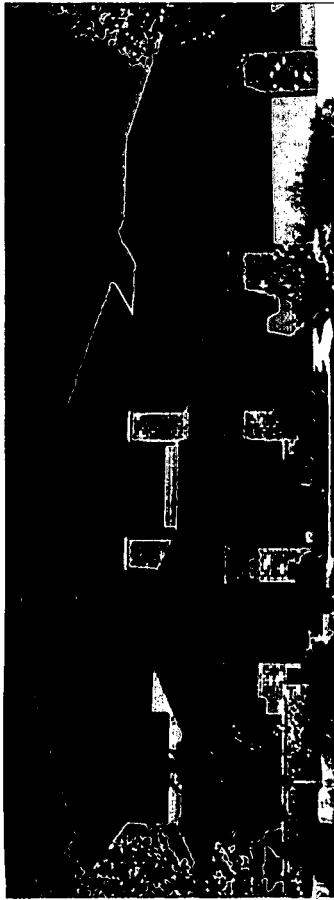

Prairie

The Prairie home is characterized by gently sloping roofs and low understated proportions. Roof overhangs are wide and extended with deep fascia. Massing is integrated with the landscape and surroundings. Natural interaction is enhanced by the creation of outdoor spaces as an extension of the interior layout.

The design has horizontal emphasis with simplified forms. Windows are large, organized and consistent in shape, while uncluttered by the omission of a grid patterns but defined by horizontal mullions or rectangular transoms. Clerestory windows are a feature.

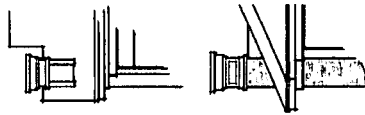
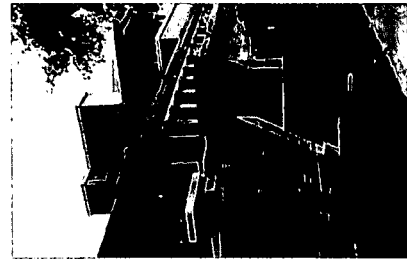

The entrance is recessed and defined by approach. A single oversized door with clear glazing and sidelites adds drama while the deep cover creates shelter and sense of arrival.

Trims and surrounds are simple and definite, providing emphasis on horizontal lines while framing openings with definition rather than decoration.

Flat panel details and stonework reinforce styling and add contrasting texture. Heavy angular knee braces are intentional supports of the extended roof lines and wide overhangs.



Prairie homes are finished in smooth stucco or traditional profile siding.

Stone or brick are required in panel effect, often with a substantial top trim in concrete or stone. Stone and brick may also be incorporated at chimneys, columns or as feature partition supports.

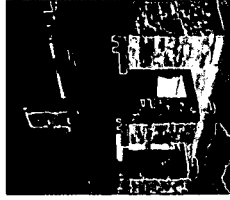

Colors suited to the Prairie style are mid to dark earth tones with monochromatic or darker trims and stone in contrast.

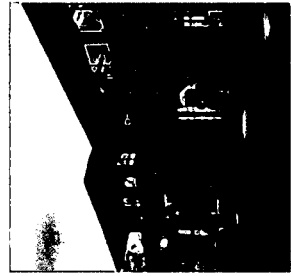
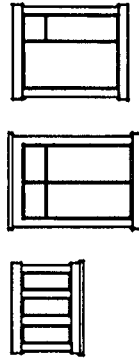
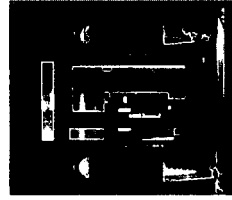

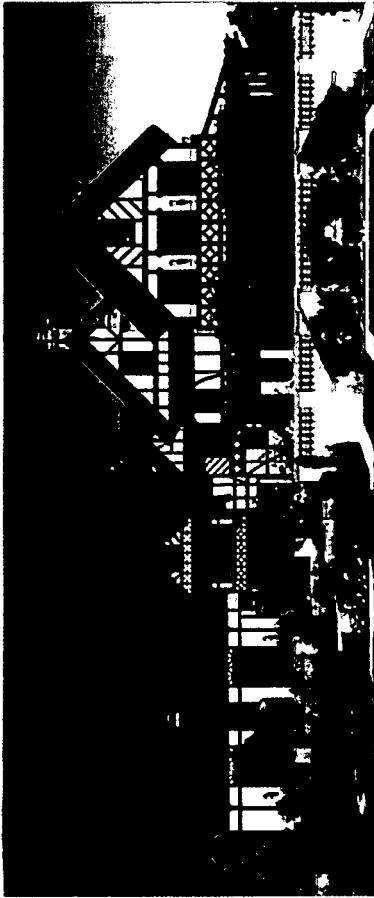

Tudor

The Tudor home is characterized by prominent, high sloping cross gables overlapping a main roof sloping to view. Roof overhangs are shallow with wide fascia. Steeply pitched roofs may be punctuated by gabled dormers.

Countryside charm is informal and decidedly European in flavor. Drawn on medieval architecture, massing of the Tudor home conveys a sense of permanence.

The design has a vertical emphasis that is asymmetrical. The beautifully patterned stonework and natural materials create a solid connection to the surroundings.

The expression of windows and doors is significant to the architectural style. Tall, narrow windows are gaged with divided panels and grids in rectangular or diamond patterns. Stained or leaded glass

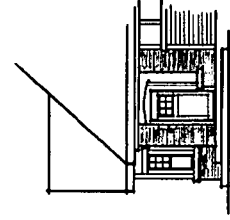
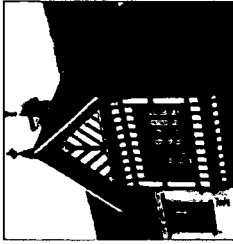
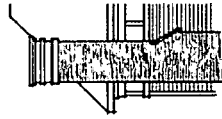
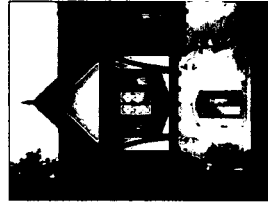
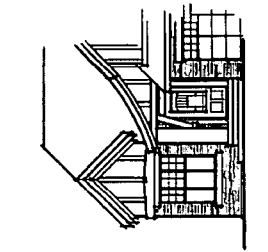

Windows add enchantment. Bayed windows with a curved roof are classic.

The entrance is recessed and celebrated with timber posts or stone columns, hefty brackets and statement defining hardware. A steep intersecting roof line, sweeping across the entry, may add a romantic prominence to arrival.

Sticking half timbering details contrast the walls and gables, in decorative vertical and curved patterns. Tudor homes are finished in smooth stucco or traditional, wide profile siding.

Stone or brick adds solidity in panel application, at fireplace chases, chimneys, or anchoring the foundation walls. Colors suited to the Tudor style are light to mid earth tones with dark fascia and timber trims in contrast.

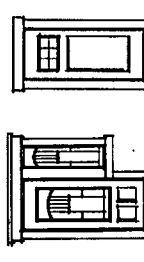
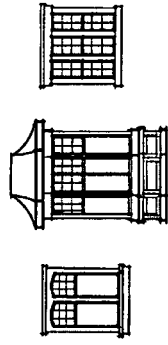
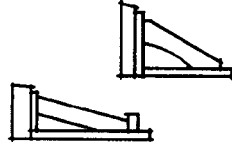
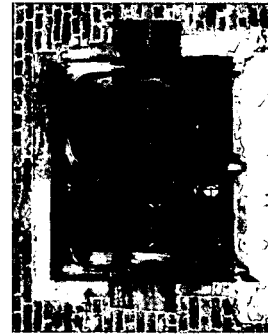

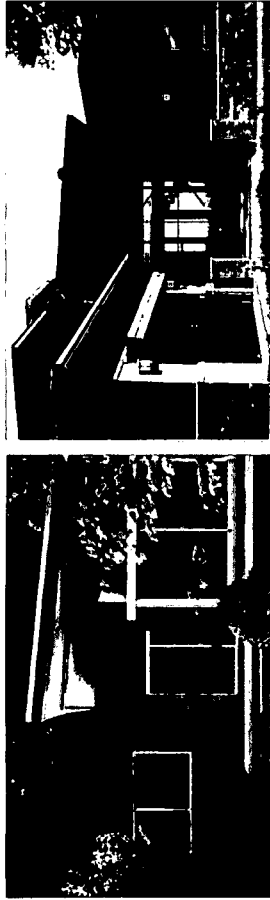

Modern Contemporary

The Modern Contemporary home is characterized by roof forms that dominate the façade. Slopes may be moderate with wide eaves or high with shallow eaves. Fascia is substantial and troughs are generally concealed. Sloped roofs may be paired with a secondary flat roof feature. Although unconventional at a glance, asymmetric elements are organized and roof pairings are intentional rather than random. Outdoor spaces extend into the living area, creating comfortable scale.

Designs will derive distinction from simplicity and restraint, with unique variations in building forms.



Rather than eschew much of the traditional form, in Jagare Ridge the Modern Contemporary will borrow from the more traditional styles with simple elegant lines rather than colliding geometric shapes. These homes will be comfortable in their proportions.

Entrances are simple, recessed, and uncluttered, framed by unique cover within the height of the main floor.

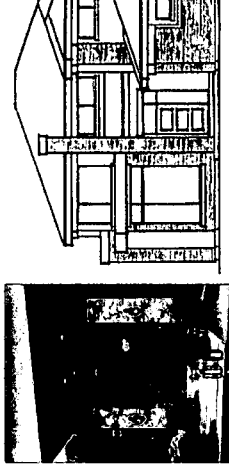
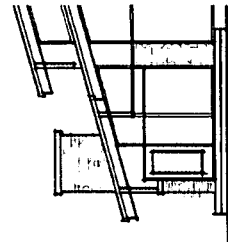

Glazing is extensive and placed with diversity. Windows will be unadorned by grills or include a single horizontal and/or vertical bar in unusual placements. Glazing is clear (not tinted or mirrored).

Horizontal elements, layered levels and staggered wall planes adjust the scale in this setting. Trims are simple and definite rather than ornamental.

Wall surfaces are smooth stucco in acrylic. Cedar paneling and long board siding may provide a warm contrast to the stucco and glass. The use of other materials or panels must be thoughtful and non-reflective. Stone or brick are required in panel effect, adding texture and strength, for relationship with the more traditional styles in the neighborhood.

Colors and finishes are natural and subtle.

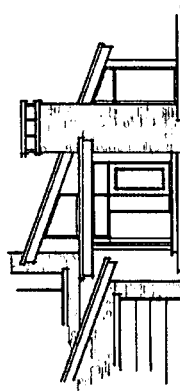
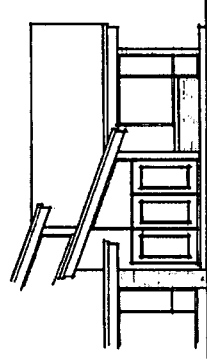

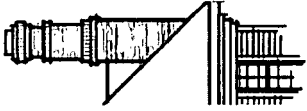
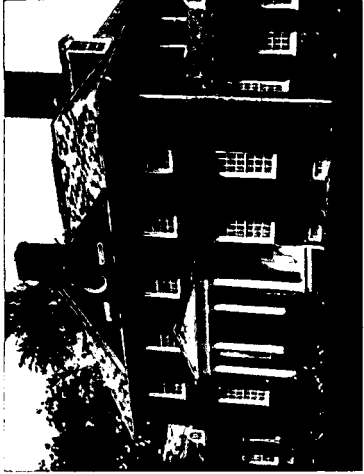

Georgian

The Georgian home is characterized by classical elegance and old world charm. Distinctly rectangular or square in shape these two story homes are stately in their massing. Balanced and symmetrical proportions create a sense of formality.

Roofs are moderately sloped with shallow overhangs. Cornice may be embellished with decorative dentil work for emphasis. Multiple narrow dormers dot the simple roof line.

Multi paned windows are dressed with sills and crowns and arranged in strict symmetry. Windows are often shuttered and round top panes may add drama.

The welcoming entry is framed with decorative crown and flattened pilasters and covered with a

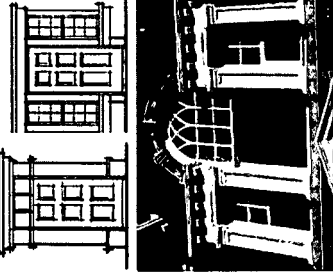
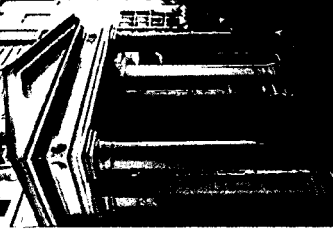
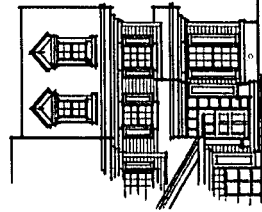

portico roof. Glazing is present in sidelites or transom below the crown. Rich brick colors dress the façade in full panel application, often adorned with quoining.

The foundation may be clad in brick as an accent to siding or stucco. Large elaborate chimneys are finished in brick and often paired.

Colors suited to the Georgian style are light to mid tone neutrals with rich dark tones of brick or stone. Trims may be contrasting or tonal.

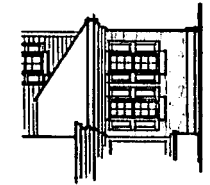



Craftsman

The Craftsman home is characterized by low-slung roof lines with ornamental detailing expressive of structural members. An inviting veranda is an integral element of the style. Roof overhangs are wide with deep fascia. Massing is comfortable with an emphasis on horizontal proportions that speaks to the theme of hearth, home and family.

Shed, gabled, or eyebrow dormers are singular and stand on their own. Windows have a vertical orientation, double hung or divided panes adorned with traditional grid pattern grills.

Trim surrounds are simple but may be tapered and include sill details. Triangular knee braces and decorative support beams are defining details.

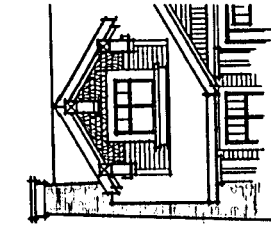

The veranda entrance is deep and sheltered, supported by tapered columns resting on a massive base. Entry doors are simple in styling and partially paneled.

Craftsman homes are finished in smooth stucco, traditional profile siding or shakes. Raised trim details are metal clad, painted or Hardie Trim.

More than one dominant finish is utilized on each elevation, applied horizontally and separated by substantial trim.

Stone or brick is applied as an accent. Application in panel effect is not suited.

Colors suited to the Craftsman style are nature-inspired palettes in darker tones accented by lighter trims.

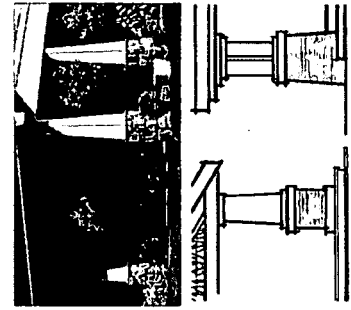
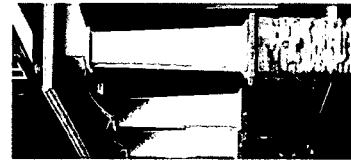
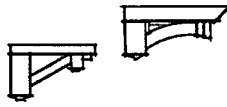
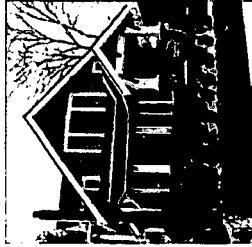
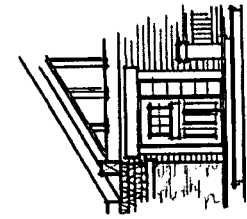
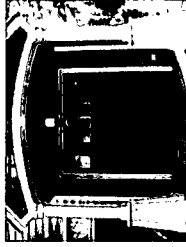
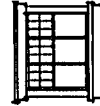
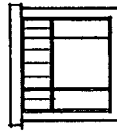



Contemporary International

The Contemporary International home is characterized by flat roofs in multiple levels, sleek lines, and understated sophistication. Roof lines may include a shallow ledge or no coping. Open, framed beam detail or wide boxed overhang may also define the form.

Volume replaces mass in an expression of functionalism. Outdoor spaces extend into the living area, creating comfortable scale.

Windows, generally metal, are set flush with outer wall and often run floor to ceiling in ribbon format or horizontally in bands that may wrap around the building corners. Large expanses of square and rectangular glazing in organized groupings are typical and often asymmetrical. Glazing is clear. Darker, mirrored or tinted commercial glazing is not suitable.

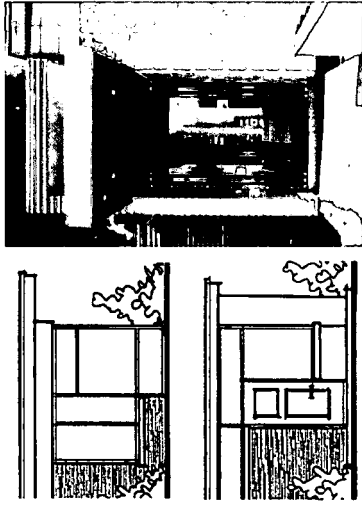
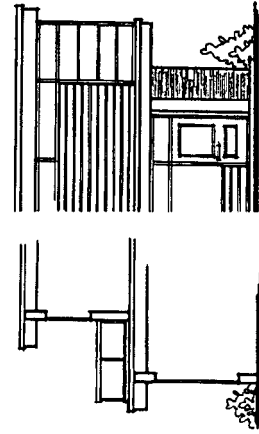

Wall surfaces are smooth and unornamented, without decorative detailing at openings. Openings may also be defined by simple narrow trims, with little or no projection.

Cantilevered projections of the house, roof or balcony may be incorporated without visible support to dramatize the style. Horizontal elements, layered levels, and staggered wall planes adjust the scale in this setting.



No structure will be permitted on the roof. This includes stair access and housing of mechanical equipment.

Entrances include cover within the height of the main floor. Entrance doors are simple in design and are often oversized and include glazing. Railing may be tubular steel and/or glass.

Exterior finish may be smooth stucco in acrylic. Cedar or exotic wood paneling may provide a warm contrast to the stucco walls. Brick or stone are required in panel effect, adding texture and solidity, for relationship with the more traditional architectural styles in the neighborhood.

Simplicity and drama are achieved without the use of geometric shapes and obtrusive colors. Colors, as with finishes, are natural and subtle.

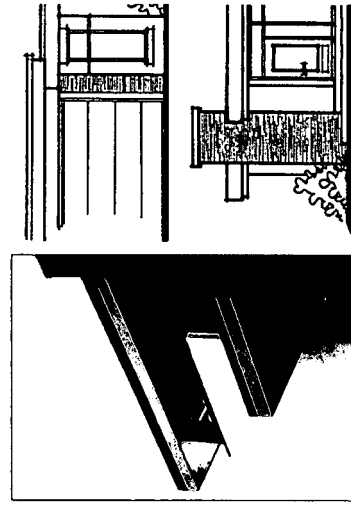

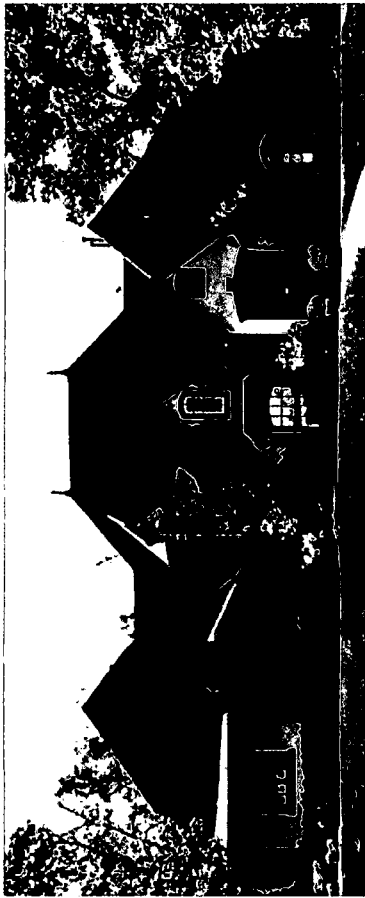

French Country

The French Country home is characterized by massive hip roofs which may include prominent front facing cross gables. This European style is enduring and timeless. Embellished with details inspired by the region and period, the French Country home is personified in Provincial, Chateausque and Normandy designs. The presentation is stately and formal with a rustic elegance.

Roof overhangs are cropped and eaves will include a stepped detail or curved cornice molding for emphasis. Rounded towers with turret roofs may be included. Narrow dormers are often featured with hipped, gabled or curved roof lines. A wrought iron 'widow walk' may add a romantic flare to the roof top.

A recessed and formal entry is low and often framed by a roof above. The entrance may be off center on the asymmetrical styles of Chateausque and Farmhouse or centered on the symmetrical Provincial style. Ground level courtyards create formality and an extension of the interior space.



Meriah Consulting Limited
January 2013

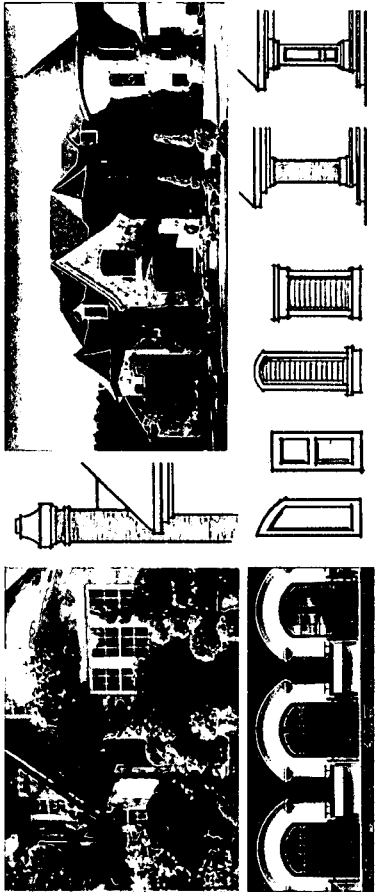

Multi paned windows are vertical in orientation and may be separated by a narrow space or ganged together. Glazing is balanced and organized, often extending to the floor. Glass doors may replace windows with an understated Juliette railing.

Bay, bow and boxed out windows, often with a curved shed roof line, add to the complexity of the facade. Decorative moldings and panel shutters match the window shapes. Curved lines and arches, chiseled stone accents and tall narrow louver details define this Old World style.

French Country homes are finished in smooth stucco and stone.

Colors suited to the French Country style are mid to dark earth tones with a dark neutral contrast at the fascia and accents. Trims may also be the same color as the ambient stucco. Stucco colors are rich and warm tones, adding to the natural finishes.



Building Massing and Siting

Building massing and siting should reflect careful consideration of lot characteristics, relationship and orientation. Building massing, siting and style may be adjusted on a lot to lot basis to enhance the streetscape. Setbacks may be adjusted accordingly.

Formal standards for development will be those as established in the City of Edmonton Land Use Bylaw. Conformity with these requirements does not supersede the required approval process of the City of Edmonton. However, it shall be the Builder's responsibility to consider the implications of zoning bylaws with respect to height, etc. when designing the home. Reduction of roof slopes to lower the overall height of a building will not be permitted to compromise the architectural integrity of the style.

House Size

Houses are to have a consistency of mass and volume within the streetscape. As such, house widths and sizes must relate proportionately to the lot width and neighboring houses.

Group A (building pocket 44' to 52'): In no case shall a house be narrower than 8.5% of the building pocket maximum defined by RFI requirements (20% sideyard).

Group B (building pocket 36' to 42'): All houses shall be a minimum width of 36' without offset of garage.

On lots with high visibility at the rear elevation, the minimum width will apply to both the front and the rear.

Minimum width is without offset of garage.

Repetition

Repetitive use of elevations and architectural styles will be monitored to ensure interesting streetscapes. Modifications to elevation treatments may be required accordingly.

Similar elevations may not be repeated within three lots or directly across the street. ~~(OXAX)~~
(OXBO).

Repetition restrictions apply to both the front and rear elevations of high visibility lots.

Repetitive use of models and architectural styles will be monitored to ensure interesting streetscapes. Modifications to elevation treatments may be required accordingly.

Site Planning and Grading

Variations in grade elevations will be absorbed within the building mass to minimize steep slopes and contrast between lots.

Lot grading must be in strict conformance with the approved grading plans. Grade variations should be absorbed within the building mass to minimize steep slopes and contrast between lots. All plot plans and stakeouts must be done by the designated surveyor, to provide consistency in establishing building elevations throughout the subdivision. An approved final grade certificate is a prerequisite to the final inspection and release of security deposit.

Exposed concrete and paving will be restricted to a maximum 1' at the front and high visibility elevations. Maximum otherwise is 2'.

Front entry steps are restricted to a maximum of three risers per set. Where the grade or design, call for more than three risers, the run must be split. Side drive garage designs may be an exception to this requirement, appropriate to architectural styling.

Retaining structures are the responsibility of the property owner and must not compromise the grading design and lot drainage. Natural elements such as rock and wood are preferred for construction of retaining walls. Landscape block can also be utilized and concrete is permitted if appropriately finished to view.

High Visibility, Special Considerations

The rear elevations of homes in high visibility locations will reflect the same stylistic definition, proportions and detailing as the front elevation.

Corner Lots

Flanking side elevations on corner lots must have full front elevation treatment, the objective being for this elevation to reflect the same stylistic definition, thoughtful detailing and massing associated with the front elevation and the architectural style.

- Appropriate wall heights
- Window placement, number of openings and appropriate configuration
- Stylistic definition and proportions consistent with the front elevation
- Variation in wall plane on all models. Two story models also require substantial roof mass between floors. Roof lines must be supported by projections and intersect with same in order to appear intentional. Preferably, roof lines are achieved with the second floor set back from the main floor.
- Stone or brick must be included at the corner elevation to reinforce styling

Walk out Lots

The rear elevation of these homes must present an integrated building form. A combination of architectural measures will be required to address suitable proportions and a lowering appearance. Graduated roof lines sloping to view, dormers, decks, detailing and articulated wall planes will be some of these measures. The distance from grade to the first substantial eave line shall not be more than 20'. Decks must be constructed concurrently.

In addition, the rear elevations of these homes must meet the requirements for high visibility.

Driveways, Garages, Walkways

Double attached, garages located in accordance with the garage location plan, designed to integrate and minimize the garage appearance while emphasizing the architectural features and massing of the house.

Oversized (24' +) and triple car garages must include articulation in the form of a jog, to break up the expanse of flat wall plane and roof line.

Maximum overhead door height @ 8'

The garage frontage on lots will not exceed 61% on lots with a 36' to 42' building pocket and 71% on lots with a 44' to 52' building pocket.

Where height between garage overhead door and eave line exceeds 18", special treatment is required to adjust massing.

Front driveways, walkways and entries will be constructed of an upgraded surface, i.e. Exposed aggregate.

Front Drive:

- 1) Driveway is not to exceed the width of the garage to the garage front where the width may then flare to include a walkway to the front and/or rear yard

Side Drive:

- a) Will be no wider than 22' at the street or boulevard, flaring out in an undulating configuration to the front of the garage
- b) A 1.5m integrating strip of landscaping must be provided between the driveway and the side property line
- c) The driveway cannot be extended in front of the garage
- d) Side driveways will not be permitted on corner lots

The Builder/Purchaser is responsible to ensure there are no obstructions or hindrances to the side driveway and minimum clearance is maintained to the satisfaction of local approving authorities. The Builder/Purchaser shall also be responsible for the relocation and hardness of any boulevard tree(s) that are in conflict with the driveway configuration.

Roofing

Shingle product approved for Jagare Ridge include:

BP	Harmony Eclipse
IKO	Cambridge Armour Shake
GAF	Timberline High Definition
Owen's Corning	Duration

Also approved for use are Cedar Shakes, Clay tile in slate profile and Steel (coated) in split shake or slate profile. Other roofing products may be considered on an individual basis. Standing seam metal roofs will not be permitted.

Roof slope and overhang will be appropriate to architectural style (See style profiles on Pages 2 - 8).

Chimneys and flues must be contained in a corbelled chase.

Exterior Finishes and Colors

Exterior finishes will be stucco, stone, brick, or lap profile siding by James Hardie or Canexel. Vinyl siding will not be permitted.

Stone may be required to reinforce architectural styling.

Colors will be appropriate to period styling.

Materials and colors will be consistent with the architectural style of the home. The caliber of presentation will be directed by the style profile.

Trim and masonry details must be returned 24" at side elevations.

Architectural Treatment of Entries

Entranceways will be a defining element of the architectural style, creating a sense of arrival.

Entry steps and verandas may be exposed aggregate or concrete clad in stone or brick.

Landscaping

The front yard landscaping will reflect maturity and compliment the architectural design of the home.

Homes backing onto the golf course will require completion of landscaping in the rear yard.

Accessories

Great architecture extends to the smallest of details. House numbers will exemplify the quality, character and styling of the home. Some examples have been provided for inspiration.

Accessory Buildings

Where structures are visible from public adjacencies (parks, golf course, water feature, flanking streets and walkways) exterior finish style and color shall complement those used on the house. Roof style and materials are to match the materials used on the roof of the house. The side wall elevations of all accessory buildings/sheds shall not extend higher than adjacent fencing.

Accessory buildings on lots backing onto the golf course must be a minimum of three meters from the rear decorative metal fencing.

Interpretation

The enforcement, administration and interpretation of these guidelines shall be at the discretion of the Jagare Ridge Homeowners Association or its designated consultant. The unfettered application of these guidelines shall be without notice or precedent.

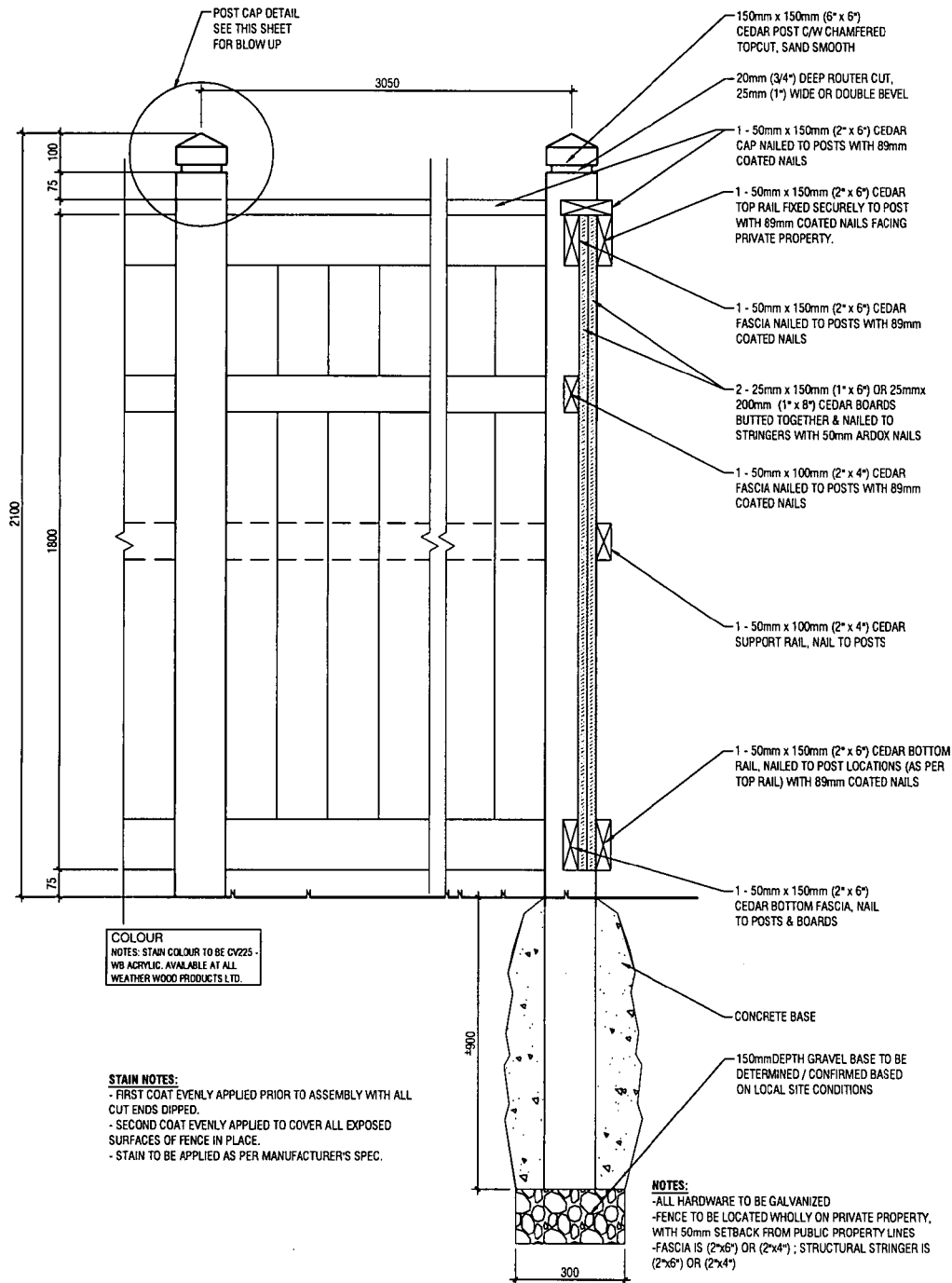
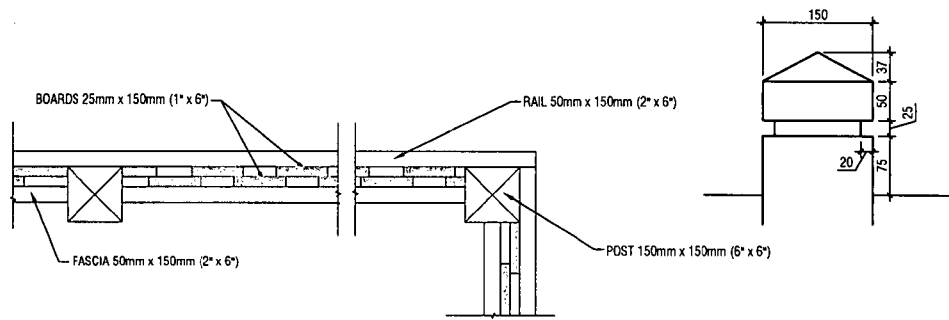

1.8M HT. CEDAR OVERLAP WOOD SCREEN FENCE

N.T.S.

PROTECTED BY



ARMOUR-SHIELD

SPECIFICATIONS

TUBE COMPOSITION - POSTS, RAILS & PICKETS

- ALLIED FLO-COAT® Triple Coated Cold Form Tubing
- Cold Formed and Quenched for High Yield and Tensile Strength
- Interior Coating Including Weld Seam with 90% Organic Zinc
- Exterior Coating Including Weld Seam with 99% Pure Zinc
- Passivation of Tube with a Chromate Conversion Coating
- Protective Sealer / Primer with Clear Organic Polymer

MATERIAL DIMENSIONS

PICKETS	5/8" x 5/8" (16mm x 16mm)	18 GA
RAILS	1-1/4" x 1-1/4" (32mm x 32mm)	16 GA
POSTS	2" x 2" (51mm x 51mm)	14 GA
OPTIONAL POSTS(1)	2" x 2" (51mm x 51mm)	11 GA
OPTIONAL POSTS(2)	2-1/2" x 2-1/2" (64mm x 64mm)	14 GA

WELDS

Stainless Steel Mig Weld

FITTINGS

14 Gauge Stamp Forged Finish as below

FITTING FASTENERS

JS1000 Plated Finish as below

OPTIONAL FASTENER

Tamper Proof Nuts

FINISH

Super Durable Polyester Powder Coat

OPTIONAL PRIMER

Zinc Rich Epoxy Powder Coat

STANDARD COLOUR

Gloss Black

OTHER COLOURS

Green, Brown, White, Antique Silver

CUSTOM COLOURS

Per Specifications

STANDARD HEIGHTS	36"	42"	48"	60"	72"
	914mm	1067mm	1219mm	1524mm	1892mm

STANDARD GATES

Passage, Double Entry, Canatleiver

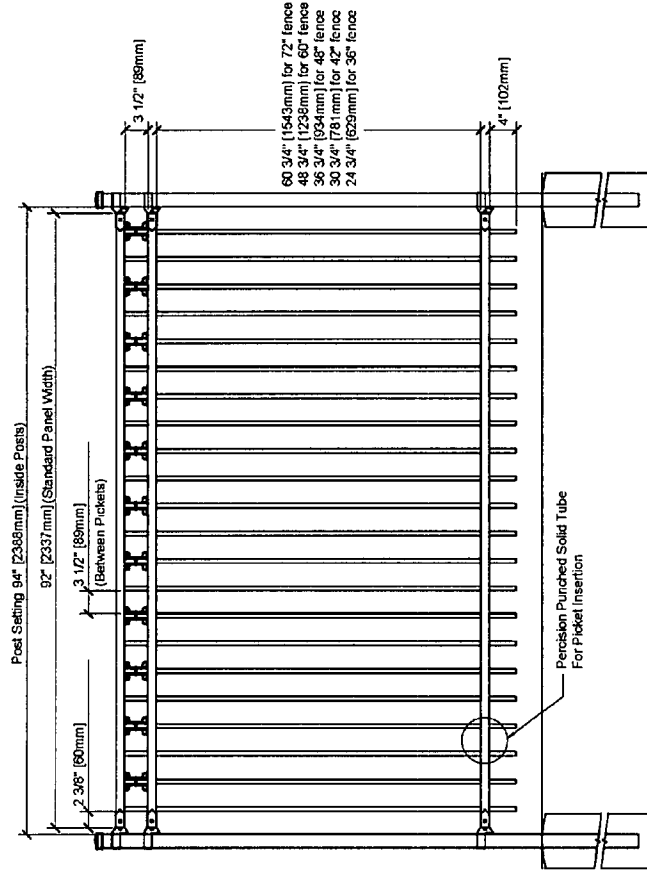
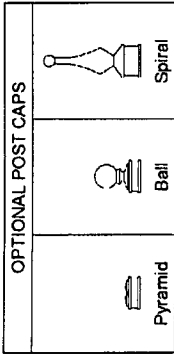

MEDALLION FENCE LTD

10651 KEELE STREET
 MAPLE, ONTARIO L6A 3Y9
 (T) 905-832-2922 || 1-800-794-1564 || (F) 905-832-1564
 info@medallionfence.com || www.medallionfence.com



MATERIAL SPECIFICATIONS:

ARMOUR-SHIELD™ BY MEDALLION FENCE

STYLE:

STANTON LXEO

SERIES:

4000

DATE: MM/DD/YYYY

06/01/2012

1.2M HT. BLACK DECORATIVE STEEL FENCE

N.T.S.

